

Pontoon 70 H/C
70 lbs thrust
24 volt 42 amps
52" shaft

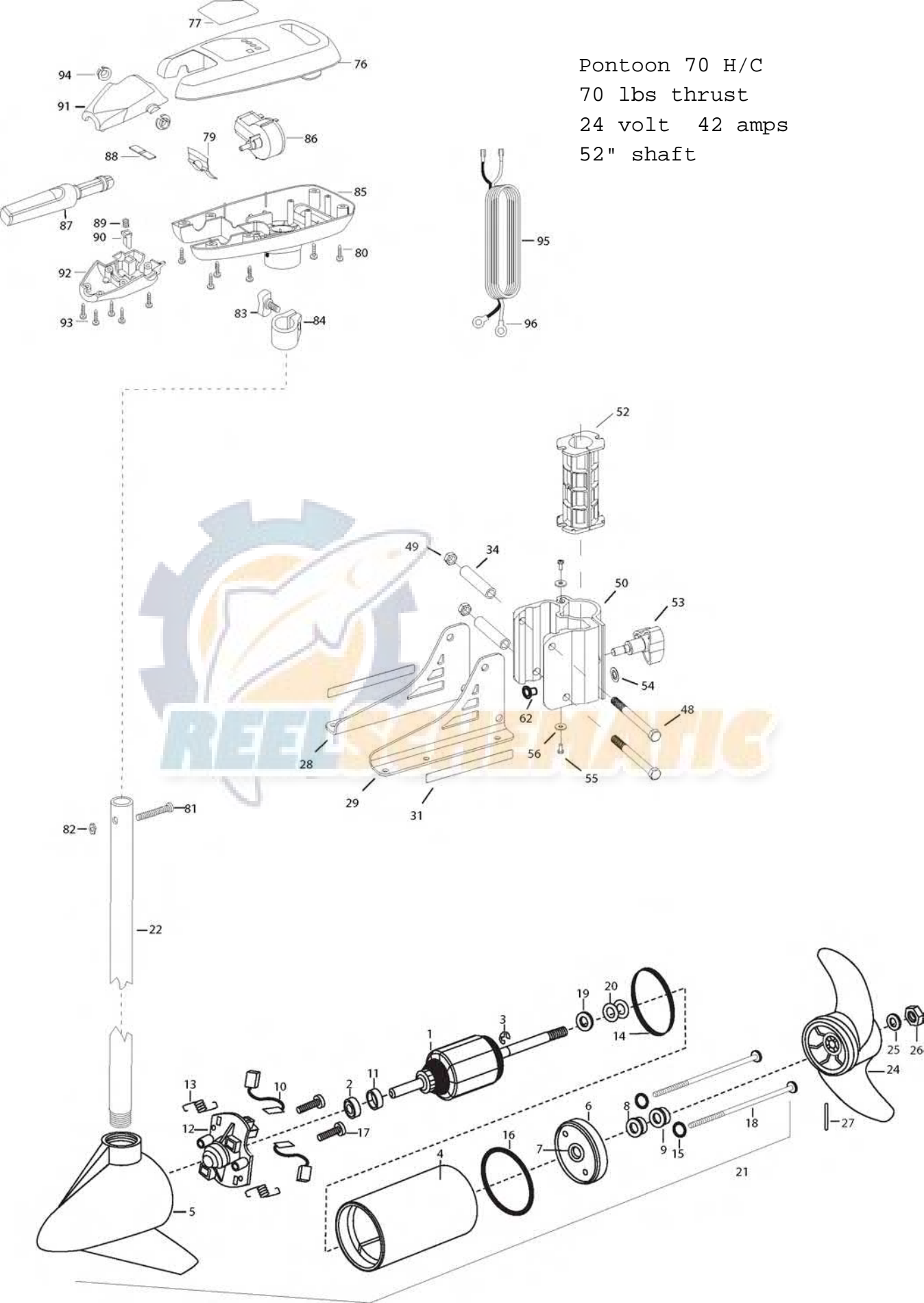

ITEM #	QTY	PART NUMBER	DESCRIPTION
1	1	2-100-119	ARMATURE ASSEMBLY 24V 3.625
2	1	140-010	BEARING-BALL
3	1	788-015	RETAINING RING
4	1	2-200-005	CENTER HOUSING ASSEMBLY
5	1	2-300-139	BRUSH END HOUSING ASSEMBLY SPDCO
6	1	2-400-101	PLAIN END HOUSING ASSEMBLY
7	1	144-049	BEARING- FLANGE SERVICE ONLY
8	1	880-003	SEAL
9	1	880-006	SEAL-W/SHIELD
10	2	188-037	BRUSH ASSEMBLY
11	1	725-035	TUBE- BRUSH RETENTION
12	1	738-036	BRUSH PLATE WITH HOLDER
13	2	975-040	SPRING- TORSION
14	1	337-036	GASKET
15	2	701-008	O-RING THRU BOLT
16	1	701-081	O-RING
17	2	830-007	#8-32 SCREW
18	2	830-008	THRU BOLT 10-32X8.83
19	1	990-067	WASHER- STEEL THRUST
20	2	990-070	WASHER-NYLATRON
21	1	2096039	MOTOR ASSEMBLY 24V F/W 3.625 5SPCO
22	1	2032068	TUBE- COMPOSITE-52"
■	1	1378131	PROPELLER KIT
*24	1	2091160	PROPELLER- W/WEDGE 2
*25	1	2151726	WASHER- 5/16 SS
*26	1	2053101	NUT-PROP NYLOC
*27	1	2092600	PIN DRIVE
■	1	2991715	PONTOON BRACKET ASSEMBLY
28	1	2261915	BRACKET, LEFT
29	1	2261916	BRACKET, RIGHT
31	2	2265689	DECAL, MINNKOTA
34	2	2261727	BRACKET SPACER
48	2	2263511	BOLT 3/8-16 X 4.0"
49	2	2263114	NUT-NYLOCK JAM 3/8-16
50	1	2991829	HINGE-DOOR-KNOB ASSEMBLY
52	2	2261537	HINGE-DOOR SLEEVE
53	1	2260905	KNOB-SOFT GRIP, L&D
54	1	2261728	WASHER-RETAINING 3/8"
55	2	2053415	SCREW #8-32 X 3/8" TRI
56	2	2261732	WASHER #8, NYLON
62	1	2264703	INSERT-THREADED
76	1	2060285	COVER-CONTROL BOX
77	1	2275618	DECAL-COVER EDGE 70/HC
79	1	2302743	SPRING-DETENT HANDLE-TILT

ITEM #	QTY	PART NUMBER	DESCRIPTION
80	6	2303412	SCREW-6-20 X 5/8 SELF TAP
81	1	2033400	SCREW-10-24 X 1-3/4
82	1	2013110	NIUT-10-24 HEX (ZCP)
83	1	2011365	SCREW-COLLAR/NEW KNOB
84	1	2031520	COLLAR-DEPTH W/O INSERT
85	1	2062551	CONTROL BOX PLAS W/ HAND
86	1	2064028	SWITCH-FWD/REV 5SP
87	1	2990912	HANDLE ASSEMBLY-W/U-JOINT 5SP
88	1	2302742	SPRING-DETENT OFF
89	1	2302745	SPRING-RELEASE BUTTON
90	1	2303720	RELEASE BUTTON-HANDLE
91	1	2060408	HANDLE- TOP HALF
92	1	2060415	HANDLE- LOWER HALF
93	5	2303412	SCREW-6-20 X 5/8 SELF TAP
94	2	2060005	BEARING-HANDLE PIVOT
95	1	2090650	LEADWIRE -10 GA RINGS
96	2	2020700	TERMINAL RING, 3/8"
■	1	2994838	BAG ASSEMBLY-BOLTS NUTS WASHERS
*98	6	2263462	SCREW 1/4-20X2 SS
*99	6	2261713	WASHER-1/4 FLAT 18-18
*100	6	2263101	NUT- 1/4-20 NYLOC-JAM
■	1	2888460	SEAL & ORING KIT



*THIS ITEM IS PART OF AN ASSEMBLY. THIS ITEM CANNOT BE SOLD SEPARATELY DUE TO MACHINING AND/OR ASSEMBLY THAT IS REQUIRED

THIS IS A UNIVERSAL MULTI-VOLTAGE DIAGRAM. DOUBLE CHECK YOUR MOTORS VOLTAGE FOR PROPER CONNECTIONS.

Pontoon 70 is 24-volt only!

FIVE SPEED SWITCH
INTERRUPTEUR A CING VITESSES

